



Creative Fabrica

**Embroidery Design
Sewing Information**

www.creativefabrica.com/embroidery/

© Creative Fabrica

Production Worksheet

Wilcom TrueSizer



Design: **Flashlight**

Title: **Flashlight**

Stitches: 13,480
Height: 2.20 in
Width: 3.81 in
Colors: 12
Colorway: Colorway 1
Zoom: 1:1

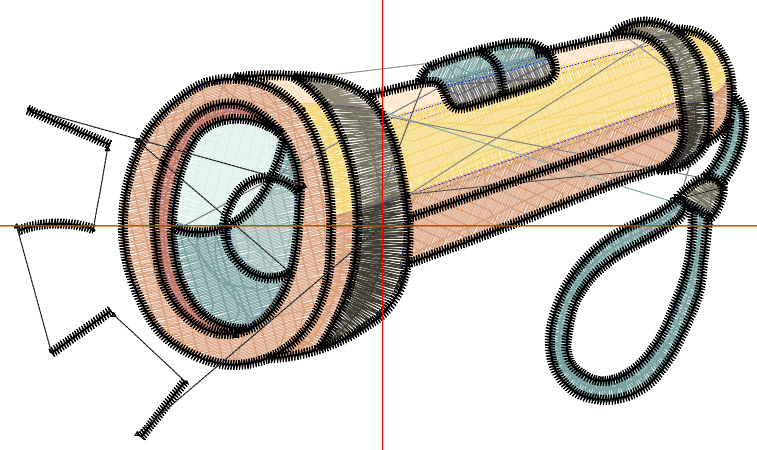

Production Worksheet

Wilcom TrueSizer



Design: **Flashlight**

Title: **Flashlight**

Stitches: 13,480
 Height: 2.20 in
 Width: 3.81 in
 Colors: 12
 Colorway: Colorway 1
 Zoom: 1:1

Machine format: Tajima
 Color changes: 13
 Stops: 14
 Trims: 23
 Auto fabric: Custom Fabric
 Required stabilizer: Topping:
 Backing: Tear Away x 2
 Appliqués: 0
 Left: 48.4 mm
 Right: 48.4 mm
 Up: 27.6 mm
 Down: 28.3 mm
 EndX: 0.00 in
 EndY: 0.00 in
 Area: 8.40 in²
 Max stitch: 12.0 mm
 Min stitch: 0.3 mm
 Max jump: 6.9 mm
 Total thread: 205.91ft
 Total bobbin: 66.88ft

Stop Sequence:

#	#	Color	St.	Code	Name	Chart
1.	37		466	Send	PMS 453	Madeira Classic 1138
2.	20		1,312	Light Yellow	PMS 114	Madeira Classic 1135
3.	21		2,282	Masturd	PMS 124	Madeira Classic 1025
4.	10		538	Orange	PMS 151	Madeira Classic 1278
5.	33		470	Gray	PMS 430	Madeira Classic 1118
6.	26		241	Light sea green	PMS 3255	Madeira Classic 1299
7.	34		363	Light Gray	PMS 429	Madeira Classic 1011
8.	38		198	Thread #18		
9.	33		194	Gray	PMS 430	Madeira Classic 1118
10.	24		623	Dark Green	PMS 3435	Madeira Classic 1370
11.	27		232	Green	PMS 355	Madeira Classic 1251
12.	33		598	Gray	PMS 430	Madeira Classic 1118
13.	22		560	Mahndi Green	PMS 3435	Madeira Classic 1370
14.	12		5,401	Black		Madeira Classic 1000

Color Film

Wilcom TrueSizer



Design: **Flashlight**

Title: **Flashlight**

Stitches: 13,480
Height: 2.20 in
Width: 3.81 in
Colors: 12
Colorway: Colorway 1
Zoom: 0.49

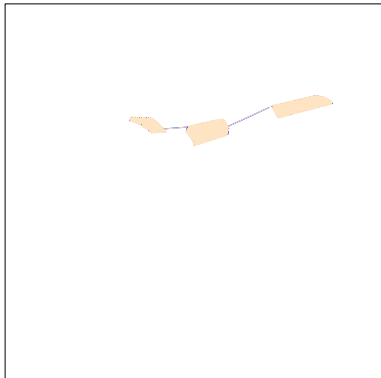

Stop #: 1
Code: Send
Name: PMS 453
Chart: Madeira Classic 1138
Stitches: 466
Thread used: 6.96ft

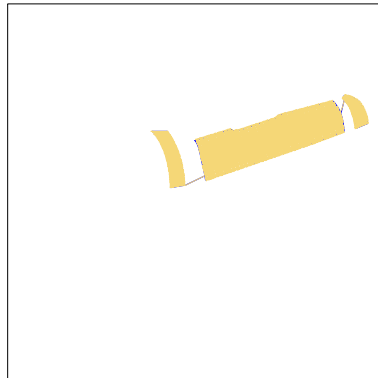

Stop #: 2
Code: Light Yellow
Name: PMS 114
Chart: Madeira Classic 1135
Stitches: 1,312
Thread used: 23.23ft

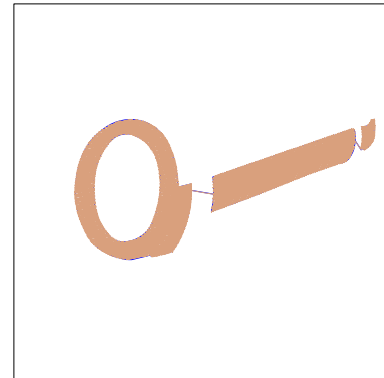

Stop #: 3
Code: Masturd
Name: PMS 124
Chart: Madeira Classic 1025
Stitches: 2,282
Thread used: 39.64ft

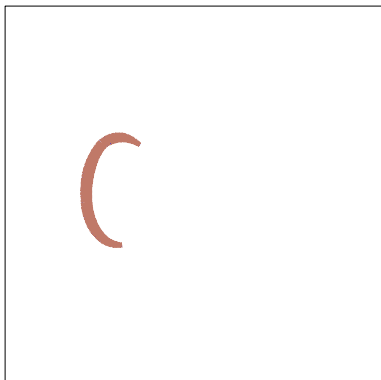

Stop #: 4
Code: Orange
Name: PMS 151
Chart: Madeira Classic 1278
Stitches: 538
Thread used: 7.23ft

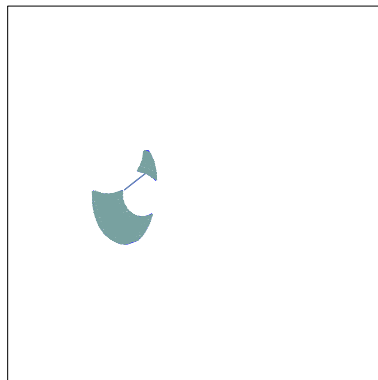

Stop #: 5
Code: Gray
Name: PMS 430
Chart: Madeira Classic 1118
Stitches: 470
Thread used: 7.94ft

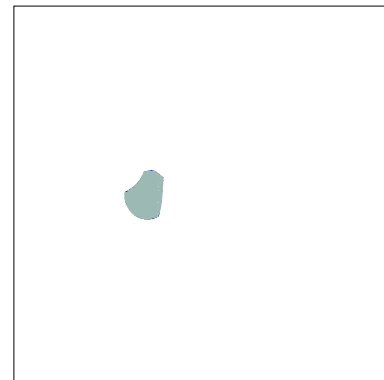

Stop #: 6
Code: Light sea green
Name: PMS 3255
Chart: Madeira Classic 1299
Stitches: 241
Thread used: 4.35ft

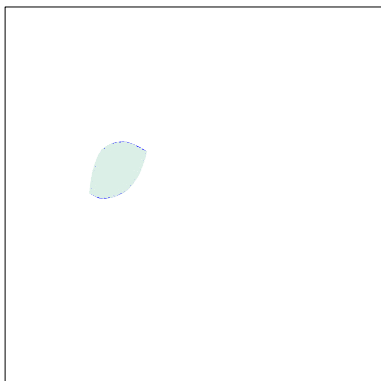

Stop #: 7
Code: Light Gray
Name: PMS 429
Chart: Madeira Classic 1011
Stitches: 363
Thread used: 6.82ft

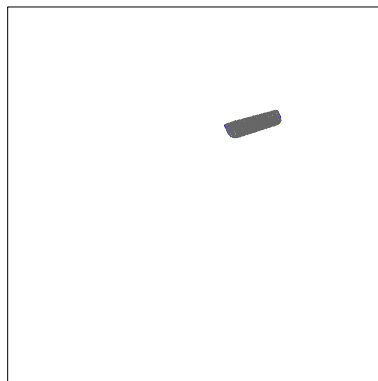

Stop #: 8
Code:
Name: Thread #18
Chart:
Stitches: 198
Thread used: 3.08ft

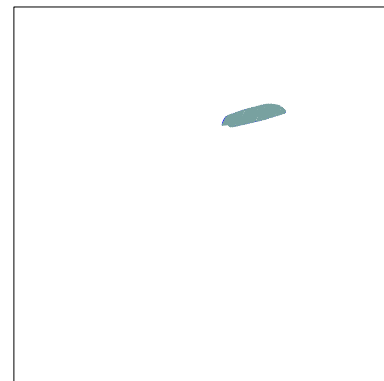

Stop #: 9
Code: Gray
Name: PMS 430
Chart: Madeira Classic 1118
Stitches: 194
Thread used: 2.91ft

Color Film

Wilcom TrueSizer



Design: **Flashlight**

Title: **Flashlight**

Stitches: 13,480
Height: 2.20 in
Width: 3.81 in
Colors: 12
Colorway: Colorway 1
Zoom: 0.49

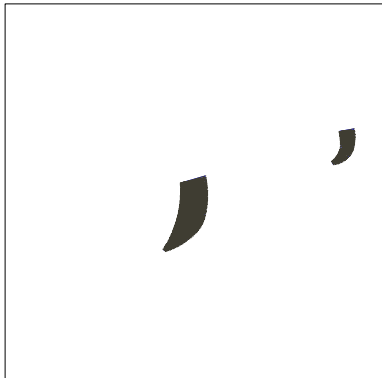

Stop #: 10
Code: Dark Green
Name: PMS 3435
Chart: Madeira Classic 1370
Stitches: 623
Thread used: 9.70ft



Stop #: 11
Code: Green
Name: PMS 355
Chart: Madeira Classic 1251
Stitches: 232
Thread used: 3.32ft



Stop #: 12
Code: Gray
Name: PMS 430
Chart: Madeira Classic 1118
Stitches: 598
Thread used: 10.71ft



Stop #: 13
Code: Mahndi Green
Name: PMS 3435
Chart: Madeira Classic 1370
Stitches: 560
Thread used: 8.83ft

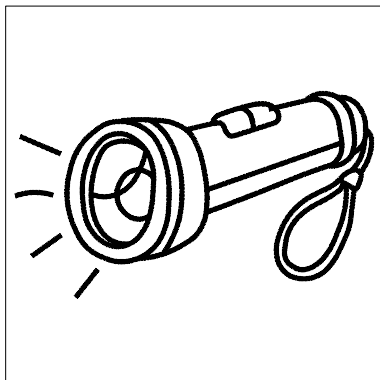

Stop #: 14
Code: Black
Name:
Chart: Madeira Classic 1000
Stitches: 5,401
Thread used: 66.59ft